

3-phase + neutral line filters FN 256

Compact general purpose three-phase and neutral line EMC filter

SCHAFFNER

energy efficiency and reliability



- Three-phase and neutral line filter for general purpose four-wire filtering
- Compact space-saving design
- Choice of connection style
- Low operating leakage current

Approvals



Technical specifications

Maximum continuous operating voltage:	3x 480/277VAC
Operating frequency:	dc to 60Hz
Rated currents:	8 to 160A @ 50°C
High potential test voltage:	P → E 2650VDC for 2 sec P → P 2100VDC for 2 sec
Protection category:	IP20
Overload capability:	IP00 (filters with connectors -28) 4x rated current at switch on, 1.5x rated current for 1 minute, once per hour
Temperature range (operation and storage):	-25°C to +100°C (25/100/21)
Flammability corresponding to:	UL 94V-2 or better
Design corresponding to:	UL 1283, CSA 22.2 No. 8 1986, IEC/EN 60939
MTBF @ 50°C/400V (Mil-HB-217F):	600,000 hours

Typical electrical schematic

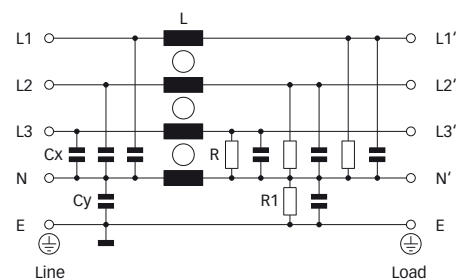



Features and benefits

- FN 256 filters are designed specifically for applications involving asymmetric loads, ranging from industrial controls to medical electronics systems. These typically involve insufficiently filtered converters and switch-mode power supplies on different phases, causing current imbalance and significant interference problems.
- Employing single-stage filter circuits for each phase and the neutral line, FN 256 filters provide high attenuation of both symmetrical and asymmetrical interference.
- Used as a mains input filter, FN 256 filters also increase conducted immunity and thus contribute to overall system reliability.
- Choice of connection style as well as filter ratings in line with common fuse values support a fast and easy application-specific filter selection and deployment.
- A light weight aluminium housing with a small footprint ensures that the filters can be easily accommodated on control panels and in tight power cabinets.

Typical applications

- General purpose four-wire filtering
- High-power office equipment
- Power supplies
- UPS
- Medical applications
- Electrical cabinets
- Control panels

Filter selection table

Filter*	Rated current @ 50°C (40°C)	Leakage current** @ 400VAC/50Hz	Power loss @ 25°C/50Hz	Input/Output connections		Weight [kg]
	[A]	[mA]	[W]			
FN 256-8-46	8 (8.8)	3.4	2.7	-46		0.8
FN 256-16-46	16 (17.5)	3.4	6.0	-46		1.1
FN 256-25-47	25 (27)	3.4	11.6	-47		1.4
FN 256-36-47	36 (39)	3.4	14.8	-47		1.5
FN 256-64-52	64 (70)	3.4	18.4	-52		2.2
FN 256-80-..	80 (88)	3.4	18.8		-28***	4.5
FN 256-120-..	120 (131)	5.0	25.1		-28***	6.1
FN 256-160-..	160 (175)	6.8	30.7		-28***	8.0

* To compile a complete part number, please replace the -.. with the required I/O connection style.

** Maximum leakage under normal operating conditions, based on the assumption that all three phases and the neutral conductor are connected to the supply and the consumer. In this case, the current will mainly return through the neutral line, not as earth leakage.

*** Filters with -28 connections are rated for 40°C environmental temperature only.

Typical filter attenuation

Per CISPR 17; A = 50Ω/50Ω sym; B = 50Ω/50Ω asym; C = 0.1Ω/100Ω sym; D = 100Ω/0.1Ω sym

8A types

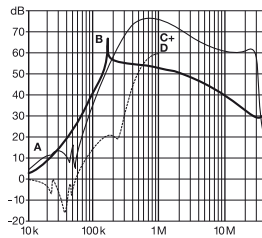

16A types

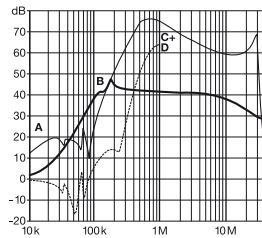

25A types

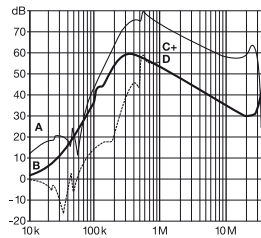

36A types

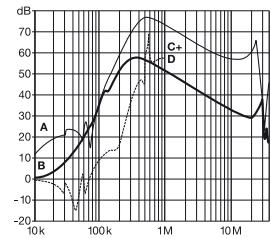

64A types

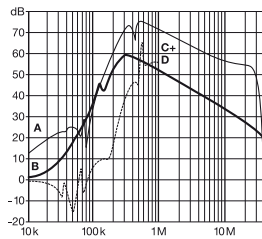

80A types

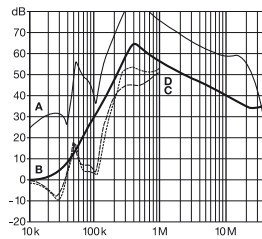

120A types

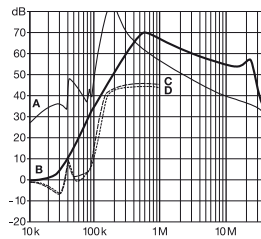

160A types

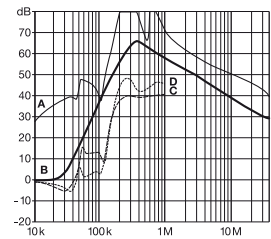

Mechanical data

8 to 64A types

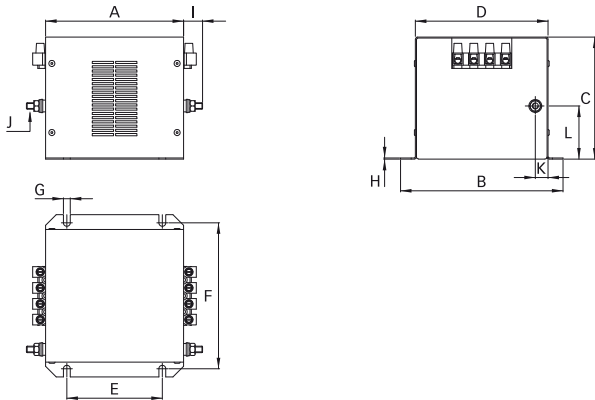

80 to 160A types (-28)

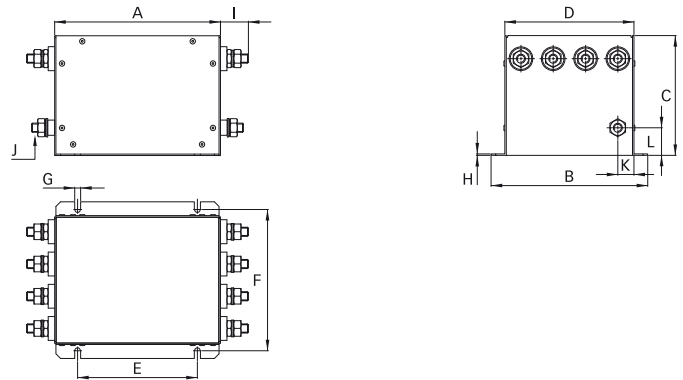

80 to 160A types (-34, -35, -40)

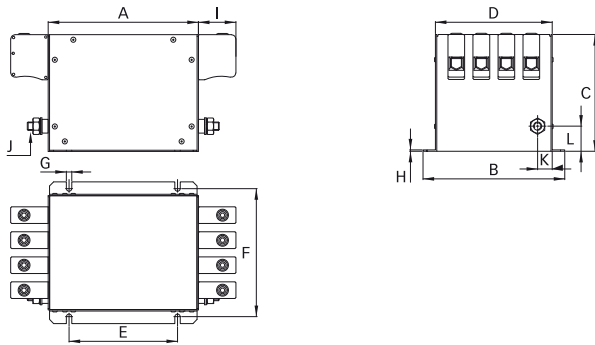

Dimensions

	8A	16A	25A	36A	64A	80A (-28)	80A (-34)	120A (-28)	120A (-35)	160A (-28)	160A (-40)
A	120	120	130	130	140	160	160	180	180	200	200
B	143	143	153	153	153	170	170	170	170	170	170
C	80	80	115	115	125	110	110	130	140	130	160
D	115	115	125	125	125	140	140	140	140	140	140
E	80	80	90	90	100	110	110	130	130	150	150
F	127.5	127.5	137.5	137.5	137.5	153.5	153.5	153.5	153.5	153.5	153.5
G	6.5	6.5	6.5	6.5	6.5	6.5	6.5	6.5	6.5	6.5	6.5
H	1	1	1	1	1.5	1.5	1.5	1.5	1.5	1.5	1.5
I	18	18	18	18	18	30	39	30	45	30	49.5
J	M6	M6	M6	M6	M6	M10	M10	M10	M10	M10	M10
K	12	12	13	13	13	17.5	17.5	17.5	17.5	17.5	17.5
L	33	33	50	50	50	30	30	30	30	30	30

All dimensions in mm; 1 inch = 25.4mm
Tolerances according: ISO 2768-m / EN 22768-m

Filter input/output connector cross sections

	-28 (M10)	-34	-35	-40	-46	-47	-52
Solid wire	n/a	35mm ²	50mm ²	95mm ²	10mm ²	16mm ²	25mm ²
Flex wire	n/a	25mm ²	50mm ²	95mm ²	6mm ²	10mm ²	16mm ²
AWG type wire	n/a	AWG 2	AWG 1/0	AWG 4/0	AWG 10	AWG 8	AWG 4
Recommended torque	17 - 18Nm	4.0 - 4.5Nm	7 - 8Nm	17 - 20Nm	0.7 - 0.8Nm	1.9 - 2.2Nm	1.9 - 2.2Nm

Please visit www.schaffner.com to find more details on filter connectors.

Your local partner: To find your local partner within Schaffner's global network, please go to www.schaffner.com